

Shapes

MBY

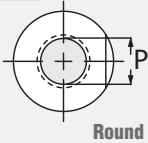

Round

MBO

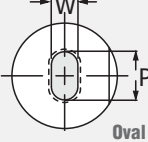

Oval

MBK

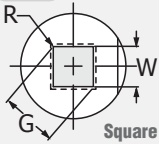

Square

MBD

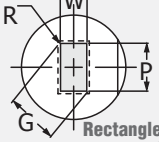

Rectangle

MBA

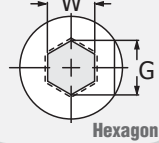

Hexagon

MBM

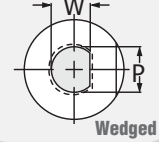

Wedged

MBX

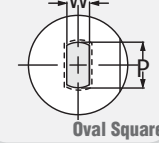

Oval Square

MBP



Parabolic

Standard Position

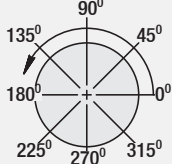

Ball Lock Matrix - Straight
Automotive Standard / Shaped Types

Code: MB..

- Inner hole conical type.
- "d2" and lead-in radius ground.

Material: 1.3343 (M2) Hardness: 60 - 62 HRC

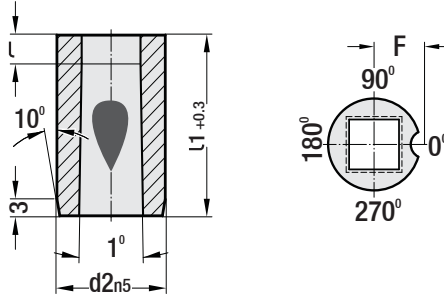

Some Shape & Dim. Details

Shape: Square

MBK $G = \sqrt{2} \times P$

Shape: Rectangle

MBD $G = \sqrt{P^2 \times W^2}$

Shape: Rectangle with radius R 0.5 ±0.01

MBD $G = \sqrt{(P-1.0)^2 + (W-1.0)^2} + 1$

Shape: Oval

MBO $G = P$

d2	F	Shape		l	l1 + 0.3 (matrix length)																	
		W	G		13	16	20	22	25	28	30	32	35	40								
10	7	1.3	6.8	3- 4-5	•	•	•	•	•	•	•	•	•	•	•	•	•	•	•	•	•	•
13	8.2	1.9	8.8	3- 5-8	•	•	•	•	•	•	•	•	•	•	•	•	•	•	•	•	•	•
16	9	1.9	10	3- 5-8			•	•	•	•	•	•	•	•	•	•	•	•	•	•	•	•
20	11	1.9	13	3-6-10				•	•	•	•	•	•	•	•	•	•	•	•	•	•	•
22	12	1.9	15	3-6-10					•	•	•	•	•	•	•	•	•	•	•	•	•	•
25	13.5	1.9	17	3-6-10						•	•	•	•	•	•	•	•	•	•	•	•	•
32	16	1.9	22	3-6-10							•	•	•	•	•	•	•	•	•	•	•	•
38	19	1.9	27	3-8-12								•	•	•	•	•	•	•	•	•	•	•
40	20	2.4	27	3-8-12									•	•	•	•	•	•	•	•	•	•
45	22.5	4.0	35	3-8-12										•	•	•	•	•	•	•	•	•
50	25	4.0	40	3-8-12											•	•	•	•	•	•	•	•
56	28	4.0	45	3-8-12												•	•	•	•	•	•	•
63	31.5	4.0	50	3-8-12													•	•	•	•	•	•
71	35.5	5.6	56	3-8-12														•	•	•	•	•
76	38	5.6	60	3-8-12															•	•	•	•
85	42.5	5.6	66	3-8-12																•	•	•
90	45	5.6	70	3-8-12																	•	•
100	50	5.6	78	3-8-12																		•

Note: Special dimensions on request.

Order: MB. (type) d2 x F x W/G (R) x l x l1



Code: MBE

Code: MBC

Ball Lock Matrix - Straight
(Blank type)

Specifications:

MBC: Inner hole conical type and lower surfaces ground.

MBE: With starting holes for "wire-edm".

Material: 1.3343 (M2)

Hardness: 60 - 62 HRC

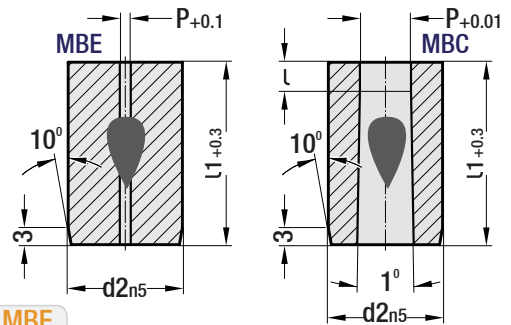
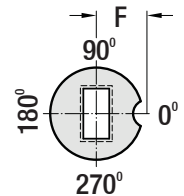

MBE

d2	P	l1 + 0.3 ("MBE" matrix length)																				
		13	16	20	22	25	28	30	32	35	40											
10	0.8	•	•	•	•	•	•	•	•	•	•	•	•	•	•	•	•	•	•	•	•	•
13	0.8	•	•	•	•	•	•	•	•	•	•	•	•	•	•	•	•	•	•	•	•	•
16	1.5			•	•	•	•	•	•	•	•	•	•	•	•	•	•	•	•	•	•	•
20	2.4				•	•	•	•	•	•	•	•	•	•	•	•	•	•	•	•	•	•
25	3.0					•	•	•	•	•	•	•	•	•	•	•	•	•	•	•	•	•
32	3.0						•	•	•	•	•	•	•	•	•	•	•	•	•	•	•	•
40	3.0							•	•	•	•	•	•	•	•	•	•	•	•	•	•	•
50	3.0								•	•	•	•	•	•	•	•	•	•	•	•	•	•
63	3.0									•	•	•	•	•	•	•	•	•	•	•	•	•
71	3.0										•	•	•	•	•	•	•	•	•	•	•	•

Order: MBE. d2 x P x l1

MBC

d2	P	l	l1 + 0.3 ("MBC" matrix length)																			
			13	16	20	22	25	28	30	32	35	40										
10	1.6 - 6.8	3-4-5	•	•	•	•	•	•	•	•	•	•	•	•	•	•	•	•	•	•	•	•
13	3 - 8.8	3-5-8	•	•	•	•	•	•	•	•	•	•	•	•	•	•	•	•	•	•	•	•
16	7.4 - 10.8	3-5-8			•	•	•	•	•	•	•	•	•	•	•	•	•	•	•	•	•	•
20	9.5 - 13.6	3-5-10				•	•	•	•	•	•	•	•	•	•	•	•	•	•	•	•	•
25	12 - 17	3-6-10					•	•	•	•	•	•	•	•	•	•	•	•	•	•	•	•
32	16 - 22	3-6-12						•	•	•	•	•	•	•	•	•	•	•	•	•	•	•
40	18 - 27	3-8-12							•	•	•	•	•	•	•	•	•	•	•	•	•	•
50	18 - 40	3-8-12								•	•	•	•	•	•	•	•	•	•	•	•	•
63	18 - 50	3-8-12									•	•	•	•	•	•	•	•	•	•	•	•
71	18 - 56	3-8-12										•	•	•	•	•	•	•	•	•	•	•

Order: MBC. d2 x P x l x l1