

Konum, İz Zımbası

Referans: FCA / STQ 40007

a	b	d1	M	c	d2	d3	t
10	8	6	M4	9.9	9.5	4.2	4
13	11.2	8	M5	12.5	12	5.2	

Sipariş: KZG x a

Kod: KZ2 - KZG

a	b	c	M	t	d	e
19	16	13	M8	8	18	8
25	18	16	M10	12	24	9

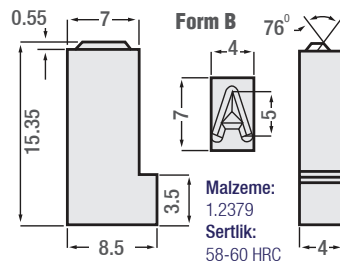
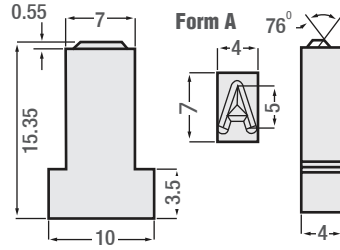

Form B

76°

4

7

15

5

4

Malzeme: 1.2379

Sertlik: 58-60 HRC

Markalama, Zımbası

Markalama Zımbaları:

Kod: MZG

İsteğe göre özel üretim yapılmaktadır.



Sipariş: MZG. Form x Sembol

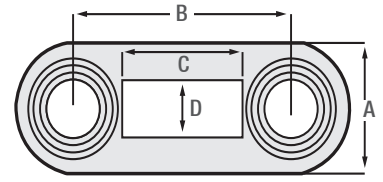
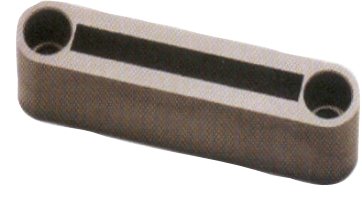

Malzeme: CK45 Sertlik: Isıt İşlemsiz

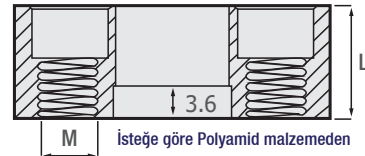

İsteğe göre Polyamid malzemeden

Markalama, Tutucusu

Kod: MTU

A	B	L	C	D	Adet	M
14.90	28	12	16.1	7.1	4	M6
	32		20.1		5	
	34		24.1		6	
	44		32.1		8	
	52		40.1		10	



Sipariş: MTU. A x B

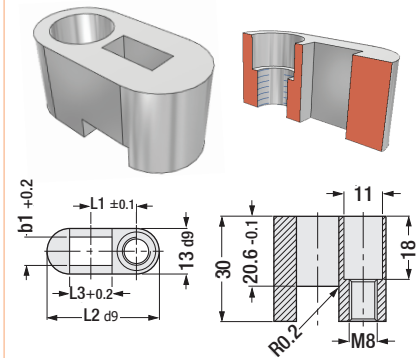

Markalama, Tutucusu

Referans: FORD / WDX20-66

Kod: MTG

L1	L2	L3	b1
9	24	4.1	8.1
11	28	8.1	
13	32	12.1	
9	24	4.1	6.1
11	28	8.1	
13	32	12.1	



Sipariş: MTG. b1 x L1

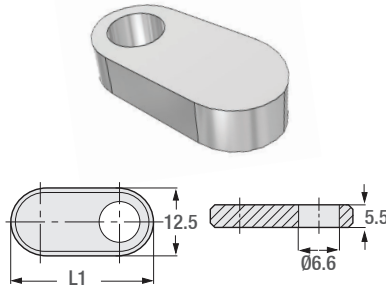

Tutucu Destek, Plakası

Referans: FORD

Kod: MEG

L1	Karakter Boyutu
23.5	3.5
27.5	3.5
31.5	3.5
23.5	2
27.5	2
31.5	2



Sipariş: MEG. L1 x Karakter Boyutu

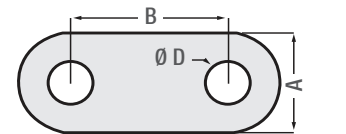

Malzeme: 1.2080 Sertlik: 54 - 56 HRC

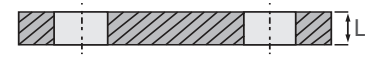

Tutucu Destek, Plakası

Kod: MEU

A	B	L	D
15	28	5	6.7
	32		
	36		
	44		
	52		



Sipariş: MEU. A x B