

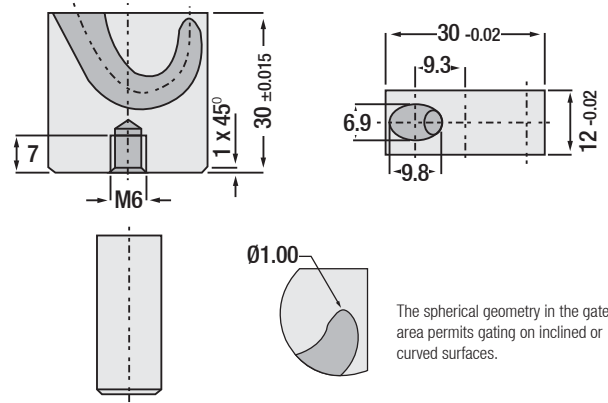

Code: GXX



Maxiflow - Contourable Gate Insert

For bottom (submarine) gating of medium to large components. Supports contouring to a depth of 11,5 mm. Suitable for gate diameters up to 3,5 mm and shot weights up to 1,200 g per insert. Suitable for all common plastics, including reinforced types.

The spherical geometry in the gate area permits gating on inclined or curved surfaces.

Order Code: GXX-1

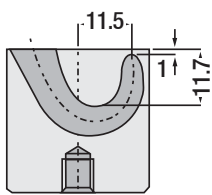

Installation Example

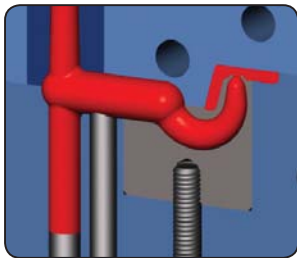

For best operating results the Maxiflow insert requires one central ejector and one supporting ejector. Please ensure that all sharp edges in the runner are thoroughly rounded. For reliable demoulding, the diameter of the runner must exceed that of the curved tunnel.

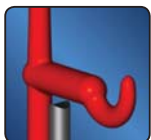

Contouring of a supporting ejector



Optimum gate geometry, with edges rounded

Maxiflow "GXX-1" Benefits

- Gating point may be located up to 10 mm above the parting line.
- Permits gating immediately behind projecting ribs.
- Gate may be remote from moulding wall.
- The spherical geometry in the gate area permits gating on inclined or curved surfaces.

Order Code: GXX-2

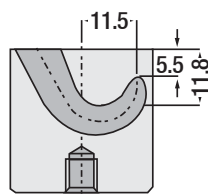

Installation Example

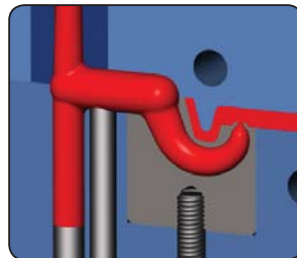

For best operating results the Maxiflow insert requires one central ejector and one supporting ejector. Please ensure that all sharp edges in the runner are thoroughly rounded. For reliable demoulding, the diameter of the runner must exceed that of the curved tunnel.



Contouring of a supporting ejector



Optimum gate geometry, with edges rounded

Maxiflow "GXX-2" Benefits

- Gating point may be located up to 5 mm above or below the parting line.
- Gate may be remote from moulding wall.
- The spherical geometry in the gate area permits gating on inclined or curved surfaces.

Order Code: GXX-3

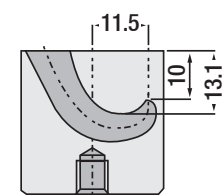

Installation Example

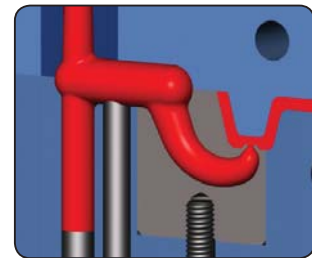

For best operating results the Maxiflow insert requires one central ejector and one supporting ejector. Please ensure that all sharp edges in the runner are thoroughly rounded. For reliable demoulding, the diameter of the runner must exceed that of the curved tunnel.



Contouring of a supporting ejector



Optimum gate geometry, with edges rounded

Maxiflow "GXX-3" Benefits

- Gating point may be located up to 10 mm below the parting line.
- Gate may be remote from moulding wall.
- The spherical geometry in the gate area permits gating on inclined or curved surfaces.

Installation Dimensions

GTM - GTR / GTE - GTK

Plastic Group	GTM	GTR/GTE	GTK
HD-PE, LD-PE PET, PP, PA PC, PVC. (L)	>15	>20	>25
Runner design	round	round	round
Ejector depth (AT)	>11	>16	>20

ABS, M ABS, ASA PS, PC-ABS POM, PBT. (L)	>20	>25	>30
Runner design	round	round	round
Ejector depth (AT)	>14	>20	>24

Elastomere TPE TPU, TPP, TPA. (L)	>15	>15	>20
Runner design	arbitrary	arbitrary	arbitrary
Ejector depth (AT)	>11	>11	>16

Brittle Plastics	>25	>30	>40
Runner design	half-round	half-round	half-round
Ejector depth (AT)	>18	>24	>32

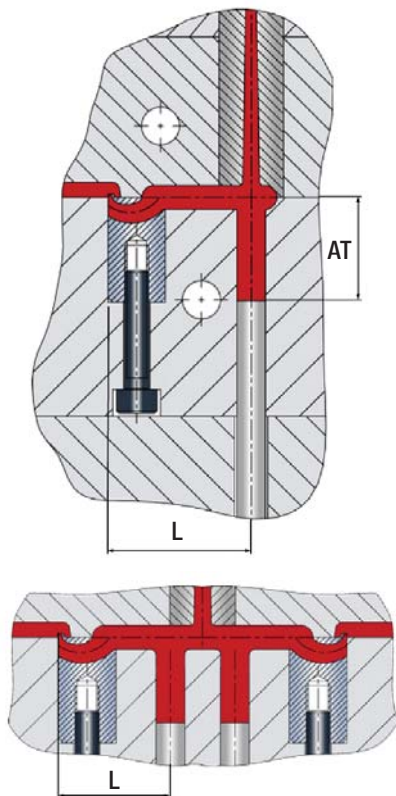

GXK - GMK

Plastic Group	GXK	GMK
HD-PE, LD-PE PET, PP, PA PC, PVC. (L)	>35	>30
Runner design	round	round
Ejector depth (AT)	>35	>30

ABS, M ABS, ASA PS, PC-ABS POM, PBT. (L)	>40	>35
Runner design	round	round
Ejector depth (AT)	>40	>35

Elastomere TPE TPU, TPP, TPA. (L)	>30	>25
Runner design	arbitrary	arbitrary
Ejector depth (AT)	>30	>16

Brittle Plastics	on request	on request
Runner design	half-round	half-round
Ejector depth (AT)	on request	on request

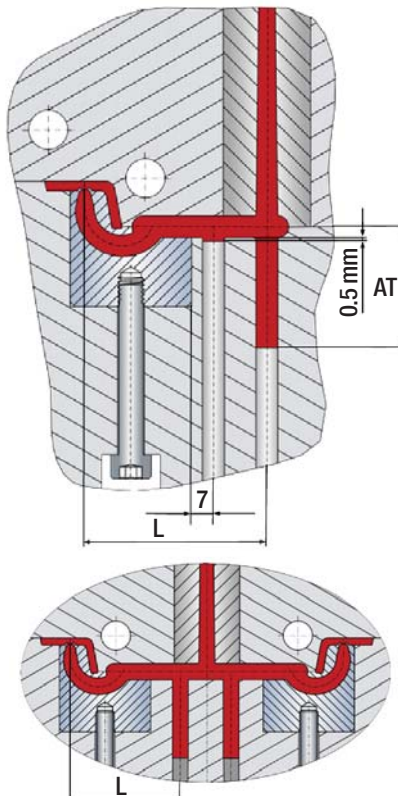

GRF-1

Plastic Group	GRF-1
HD-PE, LD-PE PET, PP, PA PC, PVC. (L)	>30
Runner design	round
Ejector depth (AT)	>30

ABS, M ABS, ASA PS, PC-ABS POM, PBT. (L)	>30
Runner design	round
Ejector depth (AT)	>30

Elastomere TPE TPU, TPP, TPA. (L)	>20
Runner design	arbitrary
Ejector depth (AT)	>20

Brittle Plastics	on request
Runner design	half-round
Ejector depth (AT)	on request

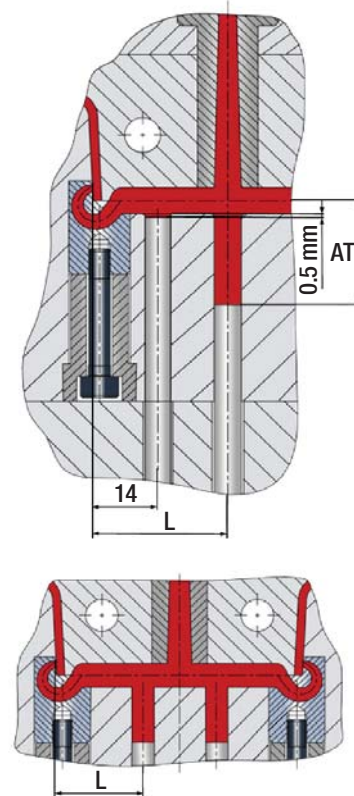

Recommended distances "L" from the injection point to the sprue ejector are given above for the various material groups. The distance "AT" describes the correlated ejector depth.

Table of Viscosity "GTR - GTE - GTM"

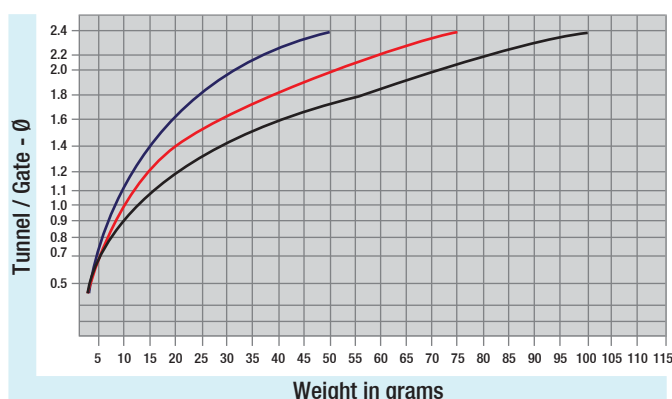

Low Viscosity: PA, PE, PC, PP, PET, PVC, PS, SB, TPA, TPE, TPU

Medium Viscosity: ABS, ASA, PS, PC-ABS, PBT, SAN

High Viscosity: PC, PPS, PSU, POM-H, PES, PPO, PEI, PC-ABS, PC-PBT, PMMA, PVC

Table of Viscosity "GTK - GMK - GXK - GRF"

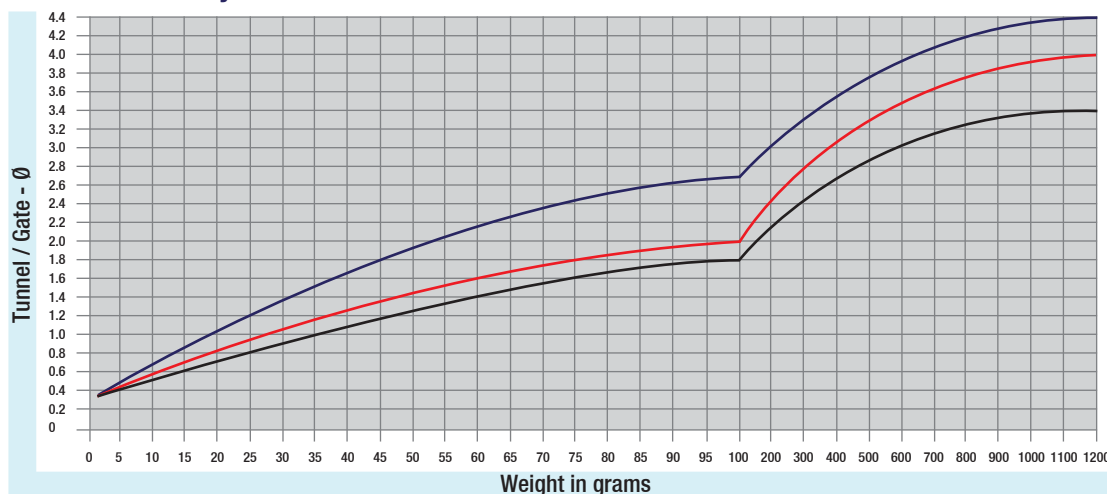

Frequently asked questions and answers about Tunnel Gate Inserts

- + **What's the ideal distance between injection point and ejector ?** - For the choice of the distance (L) we provide you with a spreadsheet in the support section. You can read about the distances depending on the type of Exaflow gate inserts and materials there. In special cases please get in touch with our application engineers.
- + **How can you prevent open jet formations ?** - An open jet formation can be prevented by following parameters: * Use of a higher gate insert diameter * Install dead-end recess * Graduated injection profile (reduce injection speed) * Increase mass temperature * Increase screw back pressure * Increase tool temperature around the area of the injection point.
- + **Can Exaflow gate inserts be used for mouldings with a wall thickness below 1,2mm ?** - For the production of mouldings with a thin wall thickness we recommend our Miniflow (without head). If a 100 % sunk gate must be warranted it's possible to grind down the head of our standard Exaflow up to 0.4 mm (please attend our application examples).
- + **Can terpolymeres be processed (PEI) ?** - Terpolymeres can be processed without any problems, however the gate diameter and the distance between gate and ejector should be designed as big as possible.
- + **Can Liquid crystal polymers be processed (LCP) ?** - LCP's can be processed without any problems, however the cold runner cross section and the gate cross section should be as small as possible since the material "lives by the shearing".
- + **How are the gating properties for polyolefins (PE,PP) ?** - Polyolefins tend to thread forming (during the demoulding process), thus during the injection moulding of flat components an impact wall around the area of the head should be installed (please attend our application examples).
- + **What does the dead-end recess do ?** - The dead-end recess has several influences on the injection process: * Decrease of shearing * Reduction of pressure loss (up to 33 % in the injection region) * Improves the laminar flow * Prevents open jet formations due to improved laminar flow and the flow front gets an unsymmetrical velocity profile which results in a spin that makes the flow front attach to the interior wall of the moulding during the ejection process and brakes the following molten mass.
- + **What is the right cross-section of the gate ?** - The cross-section of the gate depends on the processed materials, shot weight and the proportion of flow path and wall thickness. (please look at the spreadsheet in our support section). The recommended distance between gate and ejection can't be adhered. In general, Exaflow recommends a full-round cold runner cross-section. If the recommended distance can't be adhered we recommend a half-round cold runner cross-section to ensure the necessary deflection.
- + **Is a trapezoidal shaped cold runner distributor possible ?** - A trapezoidal shaped cold runner distributor is possible in general, but due to the result of its geometry it's the most constrained variant of a cold runner. For an unproblematic demoulding process a long distance between gate and ejector should be picked.
- + **How can you prevent the rough spot around the gate area ?** - Problems usually occur with high-viscosity materials (PC, PMMA, ABS). Solution: * Graduated injection profile (fills the gate region slowly) * Increase cylinder temperature, increase back pressure * Increase tool temperature * Increase gate diameter * Inject the moulded part at a different spot.
- + **Is it possible to process thermoplastic elastomers? (TPU,TPE,TPA...)** - Processing thermoplastic elastomers is possible without any problems. However you should focus, in coherence with the shore hardness, the design of the cold runner connection. You can find assistance for this in the support section.