

Die Lifters "DL36" & "DB36" / Hydraulic

Code: DL36 & DB36

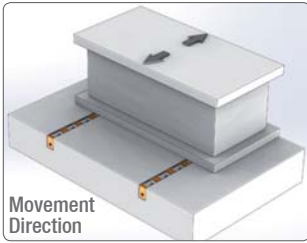

Code: DL36 (with rollers)

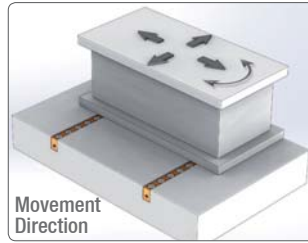

Code: DB36 (with balls)

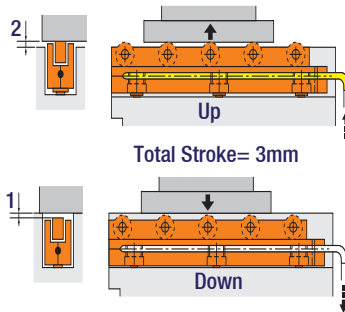

Order: Code. Type

Order Example:
DB36. 1020-0300

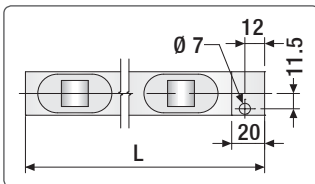

Outer Dimensions DL36 & DB36

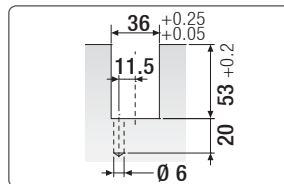

Machining Method for Plate

Die Lifters "DLS36" & "DBS36" / Spring Loaded

Code: DLS36 & DBS36

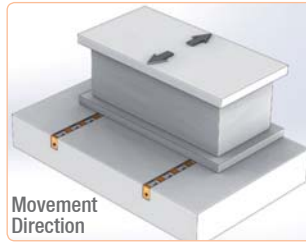

Code: DLS36 (with rollers)

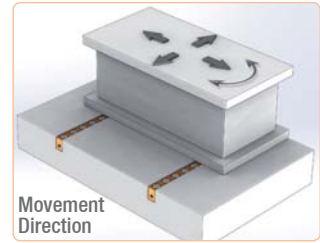

Code: DBS36 (with balls)

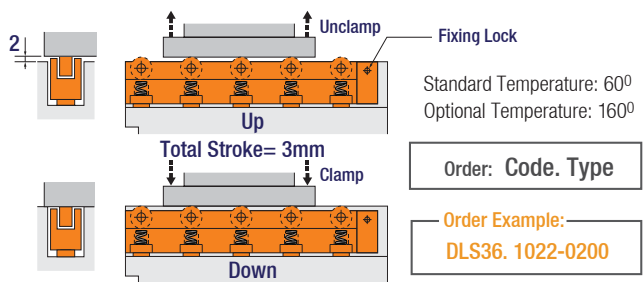

Order: Code. Type

Order Example:
DLS36. 1022-0200

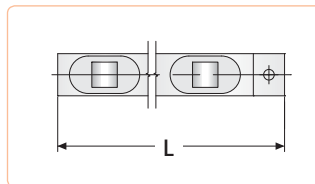

Outer Dimensions DLS36 & DBS36

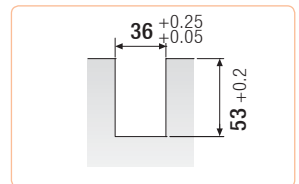

Machining Method for Plate

Type	L (mm)	DL36		DB36		Hyd. Cylinder	
		Roller	Capacity	Ball	Capacity	Piston	Capacity
1020-0200	200	3 pcs	1050 kg	5 pcs	600 kg	2 pcs	1700 kg
1020-0300	300	5	1750 kg	7	840 kg		
1020-0400	400	6	1700 kg	10	1200 kg		
1020-0500	500	8	2600 kg	12	1440 kg	3	2600 kg
1020-0600	600	9		15	1800 kg		
1020-0700	700	11		17	2040 kg		
1020-0800	800	12	3500 kg	20	2400 kg	4	3500 kg
1020-0900	900	14		22	2640 kg		
1020-1000	1000	15		25	3000 kg		
1020-1100	1100	16	4400 kg	27	3240 kg	5	4400 kg
1020-1200	1200	17		30	3600 kg		
1020-1300	1300	18		32	3840 kg		
1020-1400	1400	19	5300 kg	35	4200 kg	6	5300 kg
1020-1500	1500	20		37	4400 kg		
1020-1600	1600	22		40	4800 kg		
1020-1700	1700	24	5300 kg	42	5040 kg	6	5300 kg
1020-1800	1800	25		45	5300 kg		
1020-1900	1900	27		47			

Type	L (mm)	DLS36			DBS36		
		Roller	Capacity	Ball	Capacity	Ball	Capacity
1022-0200	200	3 pcs	3	600 kg	5 pcs	5	500 kg
1022-0300	300	5	5	1000 kg	7	7	700 kg
1022-0400	400	6	6	1200 kg	10	10	1000 kg
1022-0500	500	8	8	1600 kg	12	12	1200 kg
1022-0600	600	9	9	1800 kg	15	15	1500 kg
1022-0700	700	11	11	2200 kg	17	17	1700 kg
1022-0800	800	12	12	2400 kg	20	20	2000 kg
1022-0900	900	14	14	2800 kg	22	22	2200 kg
1022-1000	1000	15	15	3000 kg	25	25	2500 kg
1022-1100	1100	16	16	3200 kg	27	27	2700 kg
1022-1200	1200	17	17	3400 kg	30	30	3000 kg
1022-1300	1300	18	18	3600 kg	32	32	3200 kg
1022-1400	1400	19	19	3800 kg	35	35	3500 kg
1022-1500	1500	20	20	4000 kg	37	37	3700 kg
1022-1600	1600	22	22	4400 kg	40	40	4000 kg
1022-1700	1700	24	24	4800 kg	42	42	4200 kg
1022-1800	1800	25	25	5000 kg	45	45	4500 kg
1022-1900	1900	27	27	5400 kg	47	47	4700 kg